

HEATED SEAT

1

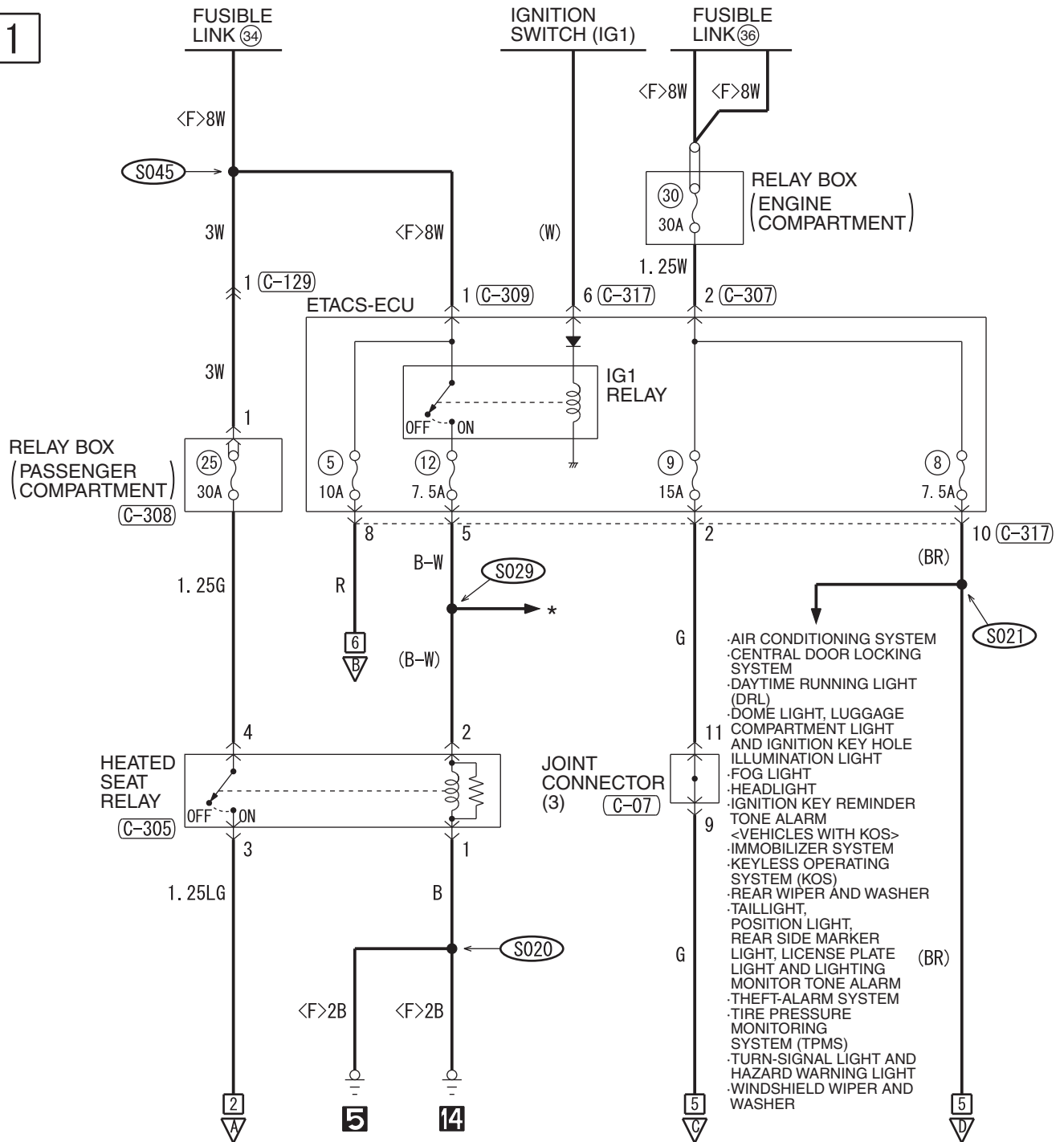

(C-07)

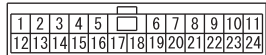

(C-23)

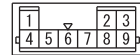

(C-26)



(C-129)



(C-305)



(C-307)



(C-308)



(C-309)



(C-317)

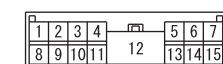

2

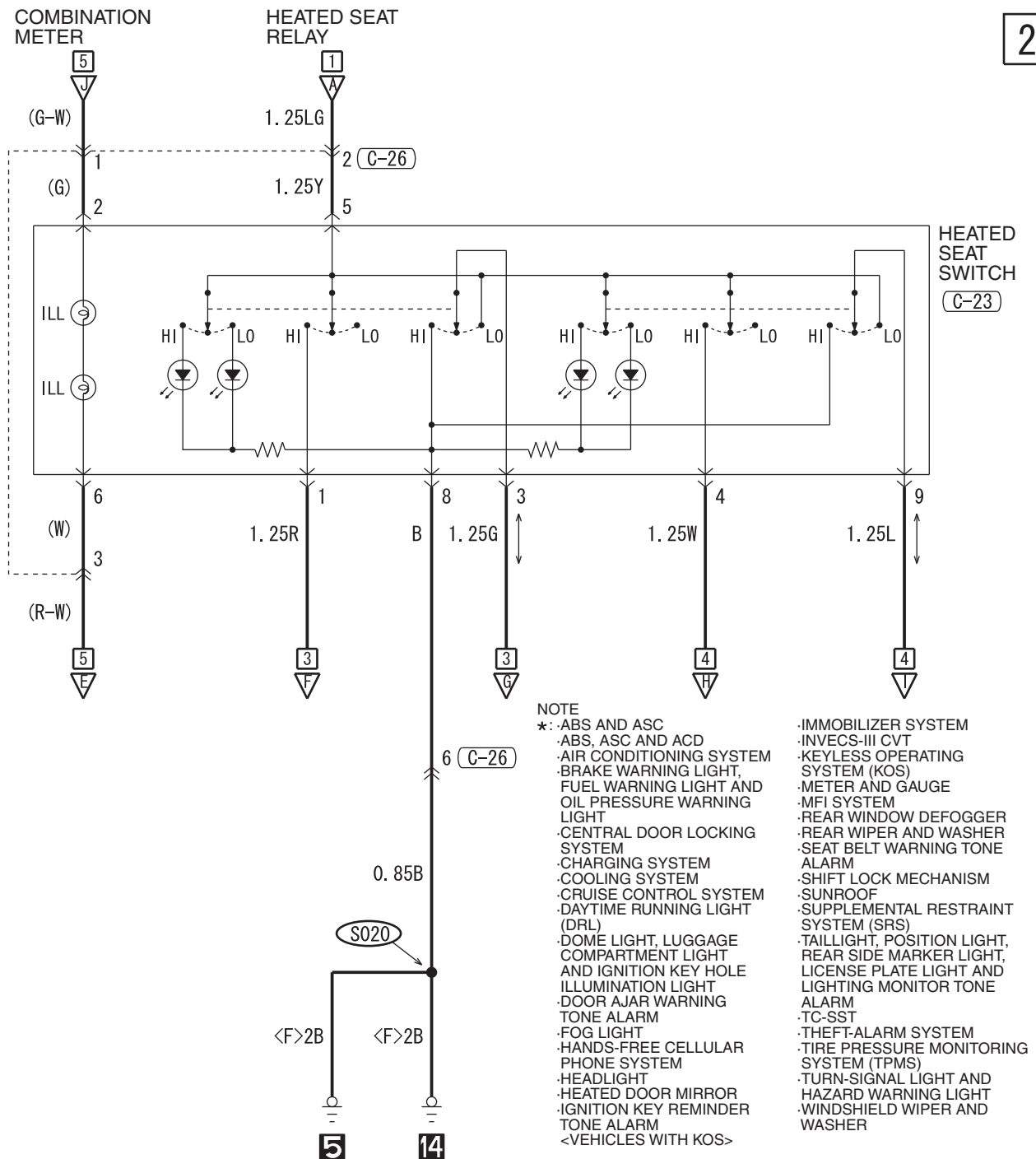

WIRE COLOR CODE

B: BLACK LG: LIGHT GREEN G: GREEN L: BLUE W: WHITE Y: YELLOW SB: SKY BLUE
BR: BROWN O: ORANGE GR: GRAY R: RED P: PINK V: VIOLET PU: PURPLE SI: SILVER

HAS15M06AB

HEATED SEAT (CONTINUED)

3

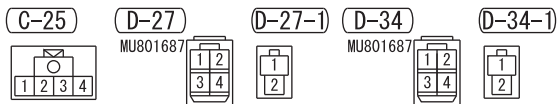
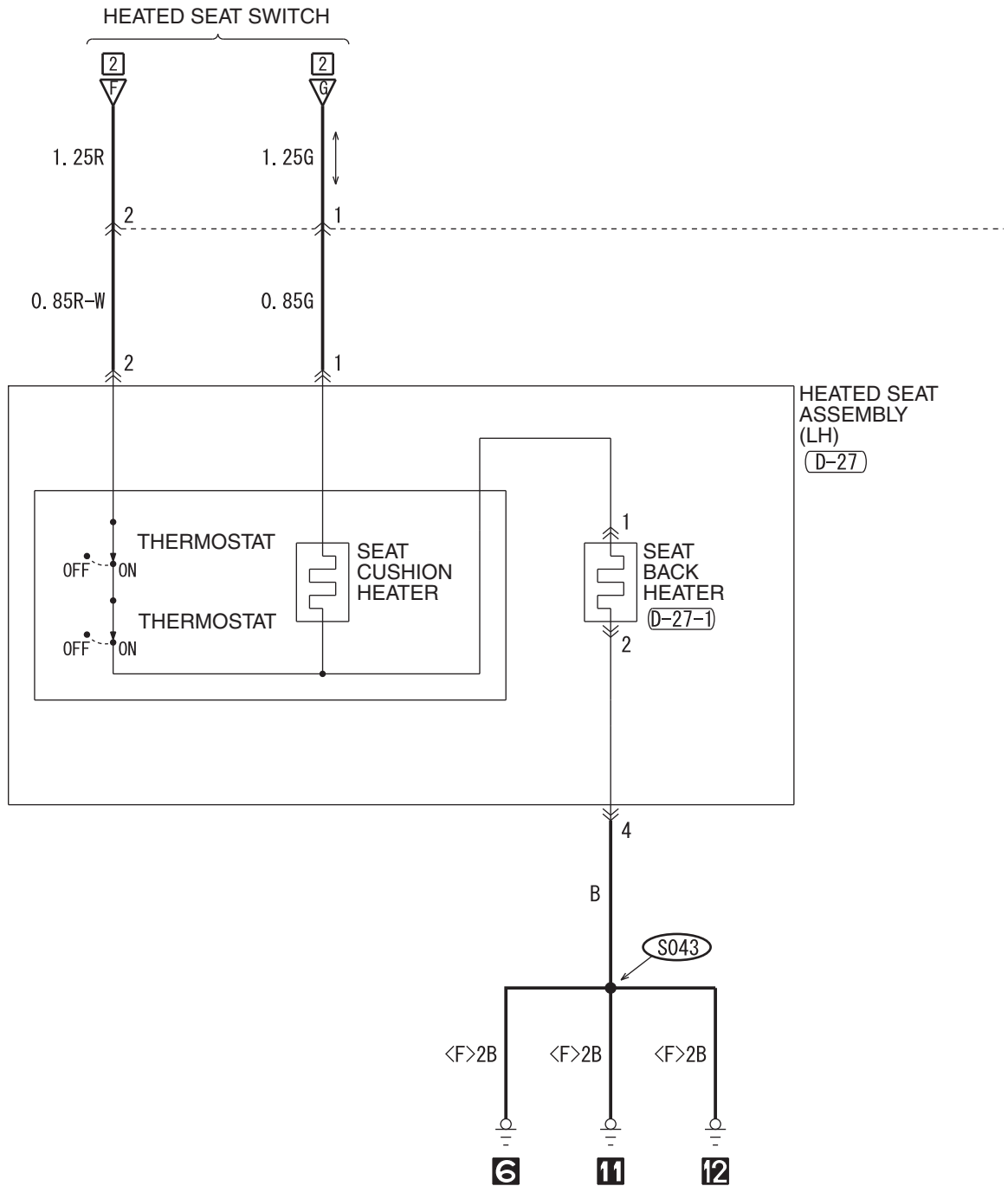

4

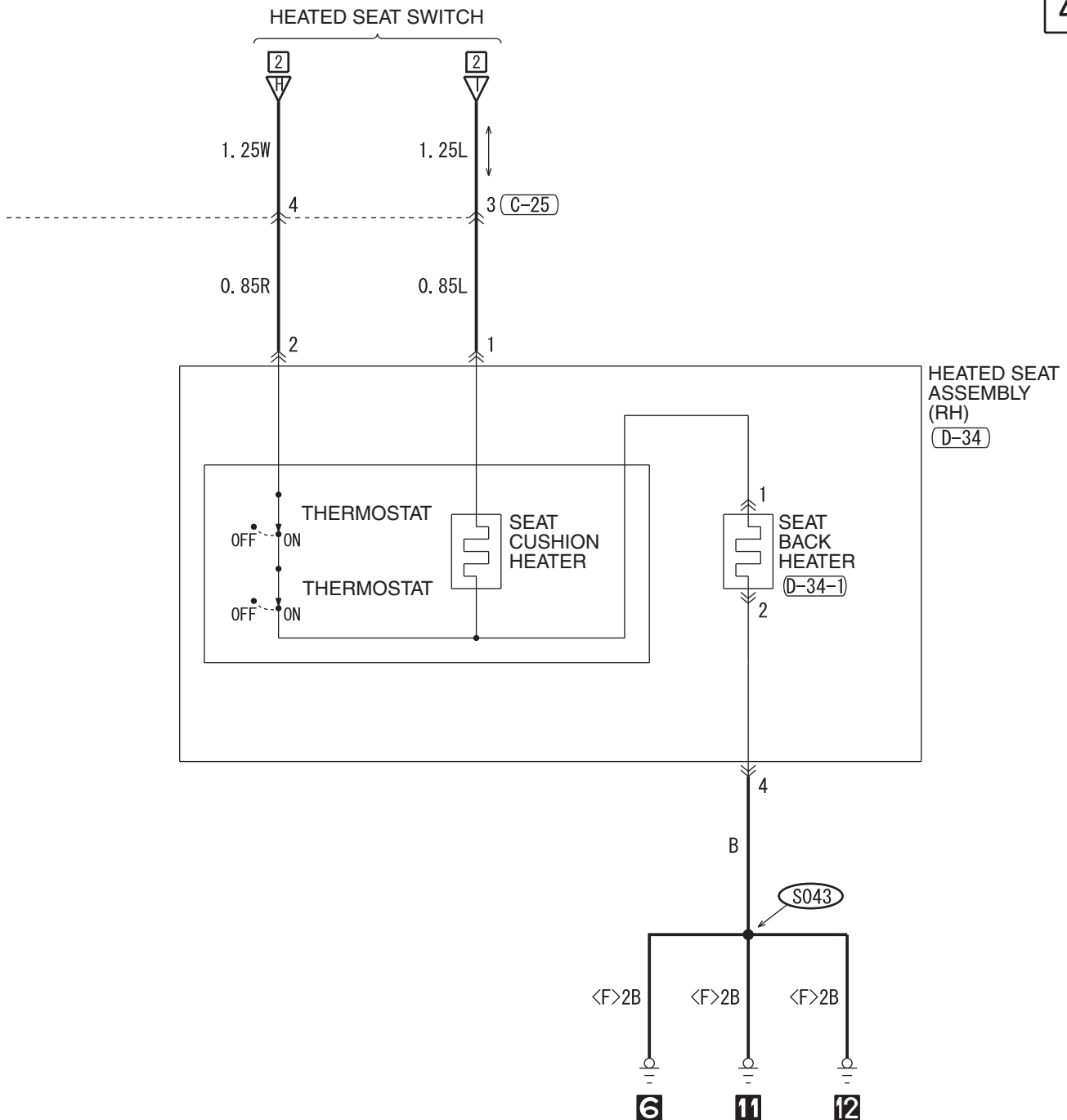

WIRE COLOR CODE
 B: BLACK LG: LIGHT GREEN G: GREEN L: BLUE W: WHITE Y: YELLOW SB: SKY BLUE
 BR: BROWN O: ORANGE GR: GRAY R: RED P: PINK V: VIOLET PU: PURPLE SI: SILVER

HAS15M06BB

TSB Revision

HEATED SEAT (CONTINUED)

5

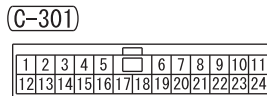
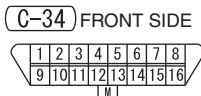
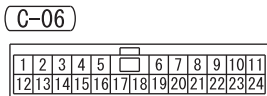
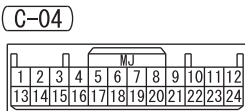
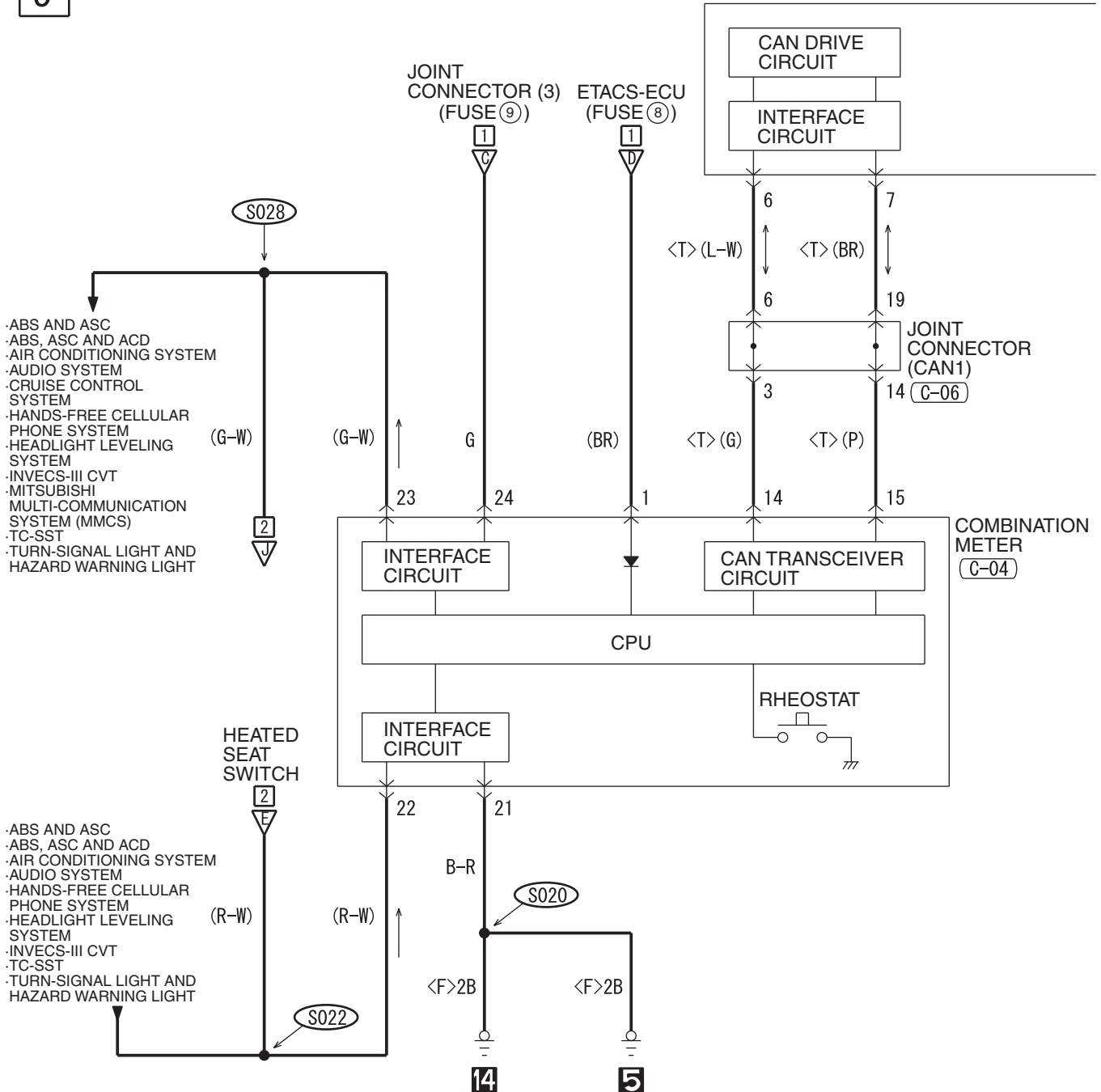

6

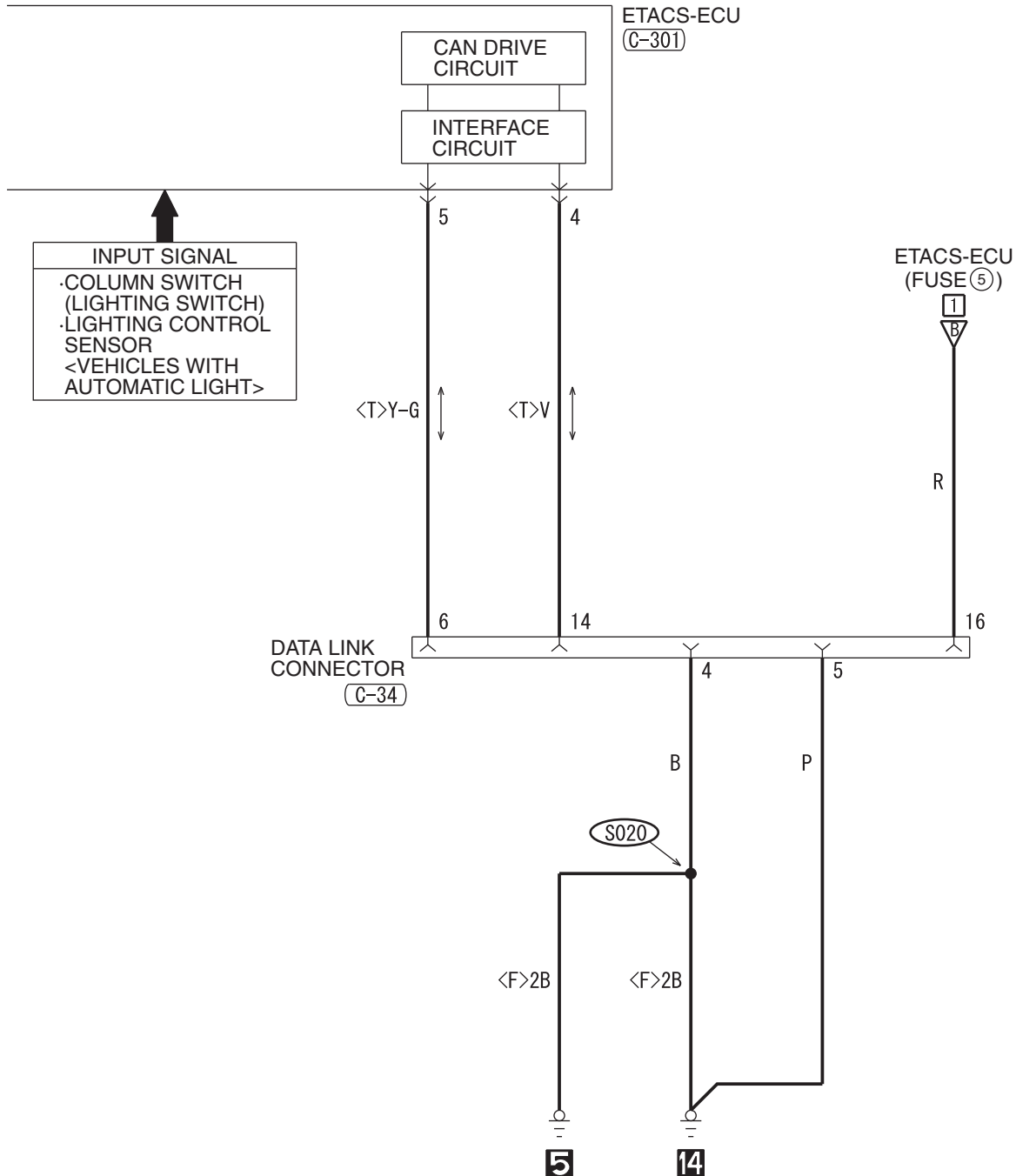

WIRE COLOR CODE

B: BLACK LG: LIGHT GREEN G: GREEN L: BLUE W: WHITE Y: YELLOW SB: SKY BLUE
BR: BROWN O: ORANGE GR: GRAY R: RED P: PINK V: VIOLET PU: PURPLE SI: SILVER

HAS15M06CB